

# Thermal Protector

## ST-12 Series

### Features

- Snap Action
- Automatic Reset
- Superior Heat Response
- Non-Phenolic Insulation
- Normally Closed

### Applications

- Hair Dryers, Electric Fan Heaters, Popcorn Machines, Electric Ovens, Dish Dryers, Blower, Small Home Appliances, etc.

### Heat Endurance

- Open Temp. +50°C/continuity, 200°C/1min

### Life Cycle(Resistive Load)



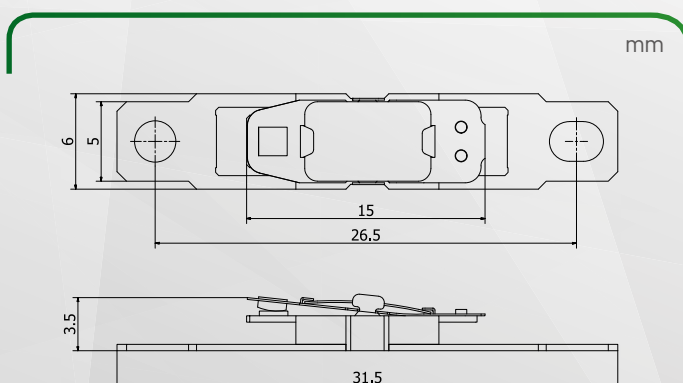
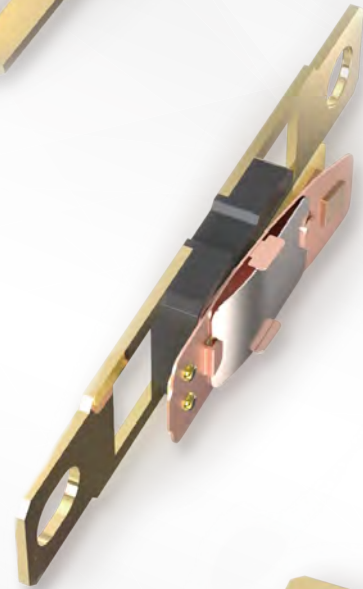
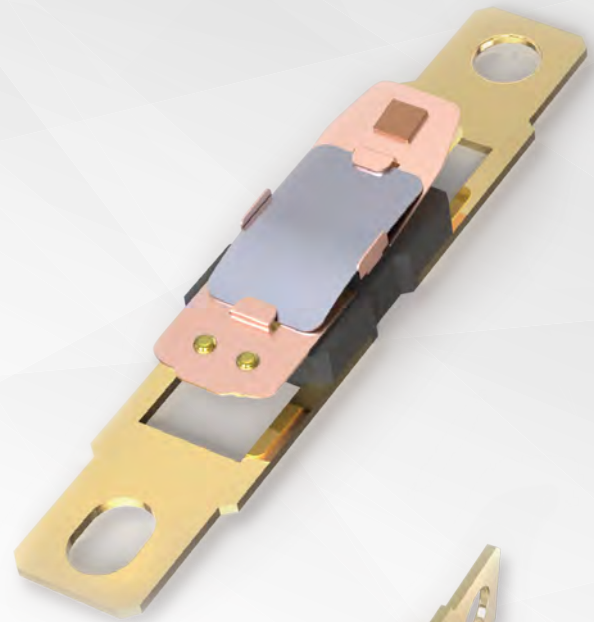

- 15A/125V AC 10,000 cycles
- 10A/250V AC 10,000 cycles
- 13A/250V AC 10,000 cycles

### Temperature Setting Range (at no load)

- 60°C ~ 150°C in increments of 5°C



## Safety Approvals

| Agency  | Standard                              | Category              | Electrical Ratings  | Max Temp | File No.           |
|---|---------------------------------------|-----------------------|---|----------|--------------------|
|  | UL 873<br>CSA C22.2 No.24             | Regulating Thermostat | AC 125V/15A, 250V/10A 10,000 cycles                                       | 150°C    | E162183            |
|  | EN 60730-1<br>EN 60730-2-9            | Thermal Cut-Out       | AC 250V/13A(5A)<br>Resistive(Inductive) 10,000 cycles                     | 150°C    | 1916600-4510-0004  |
|  | GB/T14536.1-2008<br>GB/T14536.10-2008 | Thermal Cut-Out       | Resistive AC 250V/13A 10,000 cycles<br>Inductive AC 250V/5A 10,000 cycles | 150°C    | CQC08002022429     |
|  | K60730-1<br>K60730-2-9                | Thermal Protector     | AC 250V/13A 10,000 cycles   | 150°C    | ZH02003-10002      |
|  |                                       | Thermal Cut-Out       | Resistive AC 125V/15A 10,000 cycles                                       | 150°C    | JET-14P0127(J-198) |

## Characteristics

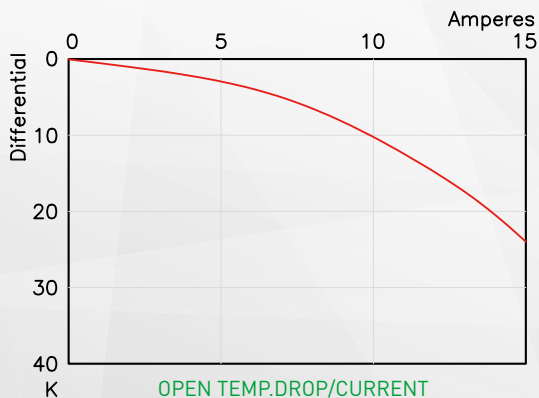
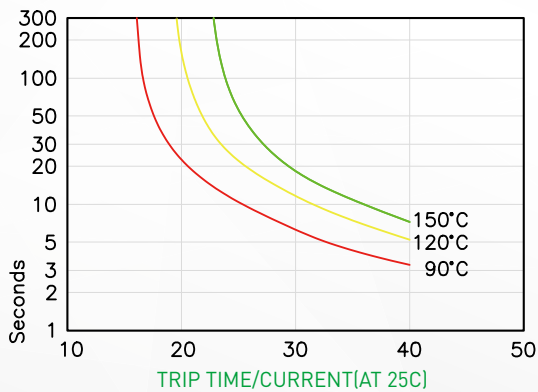

## Applications



Marketed By:

**Indian Technological Products Private Limited**

22-23, Type-B, Hartron Complex, Electronic City, Sector-18, Udyog Vihar, Gurgaon -122 016, Haryana (India)

Telephone: +91-124-4013646, 4013647 • Fax: +91-124-2398277

Email: sales@itpindia.in • [www.itpindia.com](http://www.itpindia.com) • CIN: U74899DL1986PTC023265